



# Gas Ranges

**Thank You! ... for your purchase of a GE Brand appliance.**

**Register Your Appliance:** Register your new appliance online at your convenience!

[www.geappliances.com/service\\_and\\_support/register/](http://www.geappliances.com/service_and_support/register/)

Timely product registration will allow for enhanced communication and prompt service under the terms of your warranty, should the need arise. You may also mail in the pre-printed registration card included in the packing material.

For a full manual in English and Spanish visit • Para un manual completo en inglés y español

[www.GEAppliances.com](http://www.GEAppliances.com)

Or call to order a paper copy • O llame para pedir una copia de papel

800.626.2000

You will need to have your model number ready before you call.

## IMPORTANT SAFETY INFORMATION

Read all safety instructions before using the product.



**WARNING**

If the information in this manual is not followed exactly, a fire or explosion may result, causing property damage, personal injury or death.

- Do not store or use gasoline or other flammable vapors and liquids in the vicinity of this or any other appliance.
- **WHAT TO DO IF YOU SMELL GAS**
  - Do not try to light any appliance.
  - Do not touch any electrical switch; do not use any phone in your building.
  - Immediately call your gas supplier from a neighbor's phone. Follow the gas supplier's instructions.
  - If you cannot reach your gas supplier, call the fire department.
- Installation and service must be performed by a qualified installer, service agency or the gas supplier.

## ANTI-TIP DEVICE

### WARNING

#### Tip-Over Hazard

A child or adult can tip the range and be killed. Verify the anti-tip bracket has been properly installed and engaged. Ensure the anti-tip bracket is re-engaged when the range is moved. Do not operate the range without the anti-tip bracket in place and engaged. Failure to follow these instructions can result in death or serious burns to children or adults.

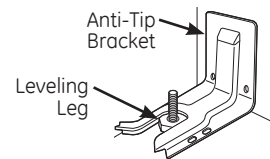

To reduce the risk of tipping the range, the range must be secured by a properly installed anti-tip bracket. See installation instructions shipped with the bracket for complete details before attempting to install.

To check if the bracket is installed and engaged properly, look underneath the range to see that the rear leveling leg is engaged in the bracket. On some models, the storage drawer or kick panel can be removed for easy inspection. If visual inspection is not possible, slide the range forward, confirm the anti-tip bracket is securely attached to the floor or wall, and slide the range back so the rear leveling leg is under the anti-tip bracket.

If your range is removed for cleaning, servicing or any reason, be sure the anti-tip device is reengaged properly when the range is replaced. Failure to take this precaution could result in tipping of the range and can result in death or serious burns to children or adults.

Never completely remove the leveling legs or the range will not be secured to the anti-tip device properly.

## READ AND SAVE THESE INSTRUCTIONS

# IMPORTANT SAFETY INFORMATION

**⚠** This is the safety alert symbol. This symbol alerts you to potential hazards that can kill or hurt you and others. All safety messages will follow the safety alert symbol and the word “DANGER”, “WARNING”, or “CAUTION”. These words are defined as:

- ⚠ DANGER** Indicates a hazardous situation which, if not avoided, **will** result in death or serious injury.
- ⚠ WARNING** Indicates a hazardous situation which, if not avoided, **could** result in death or serious injury.
- ⚠ CAUTION** Indicates a hazardous situation which, if not avoided, **could** result in minor or moderate injury.

## STATE OF CALIFORNIA PROPOSITION 65 WARNING

The California Safe Drinking Water and Toxic Enforcement Act requires the Governor of California to publish a list of substances known to the state to cause cancer, birth defects or other reproductive harm, and requires businesses to warn customers of potential exposure to such substances.

**⚠ WARNING** This product contains one or more chemical known to the State of California to cause cancer, birth defects or other reproductive harm.

Self-clean ovens can cause low-level exposure to some of these substances, including carbon monoxide, during the cleaning cycle. Exposure can be minimized by venting with an open window or using a ventilation fan or hood.

## **⚠ WARNING** GENERAL SAFETY INSTRUCTIONS

**⚠ WARNING** **NEVER use this appliance as a space heater to heat or warm the room. Doing so may result in carbon monoxide poisoning and overheating of the oven.**

- Use this appliance for its intended purpose as described in this owner’s manual.
- Have your range installed and properly grounded by a qualified installer in accordance with the provided installation instructions.
- Any adjustment and service should be performed only by a qualified gas range installer or service technician. Do not attempt to repair or replace any part of your range unless it is specifically recommended in this manual.
- Your range is shipped from the factory set for use with natural gas. It can be converted for use with propane gas. If required, these adjustments must be made by a qualified technician in accordance with the installation instructions and local codes. The agency performing this work assumes responsibility for the conversion.
- Have the installer show you the location of the range gas shut-off valve and how to turn it off if necessary.
- Plug your range into a 120-volt grounded outlet only. Do not remove the round grounding prong from the plug. If in doubt about the grounding of the home electrical system, it is your responsibility and obligation to have an ungrounded outlet replaced with a properly grounded, three prong outlet in accordance with the National Electrical Code. Do not use an extension cord with this appliance.
- Before performing any service, turn off the gas supply and unplug the range or disconnect the power supply at the household distribution panel by removing the fuse or switching off the circuit breaker.
- Be sure all packing materials are removed from the range before operating to prevent ignition of these materials.
- Avoid scratching or impacting glass doors, cooktops or control panels. Doing so may lead to glass breakage. Do not cook on a product with broken glass. Shock, fire or cuts may occur. Contact a qualified technician immediately.
- Do not leave children alone or unattended in an area where an appliance is in use. They should never be allowed to climb, sit or stand on any part of the appliance
- **⚠ CAUTION** Do not store items of interest to children above a range or on the backguard of a range - children climbing on the oven to reach items could be seriously injured.
- Never block the vents (air openings) of the range. They provide the air inlets and outlets that are necessary for the range to operate properly with correct combustion. Air openings are located at the rear of the cooktop, at the top and bottom of the oven door, and at the bottom of the range under the warming drawer, lower oven drawer or kick panel.
- Use only dry pot holders—moist or damp pot holders on hot surfaces may result in burns from steam. Do not let pot holders touch surface burners, burner grate, or oven heating element. Do not use a towel or other bulky cloth in place of pot holders.
- Do not touch the heating elements or the interior surface of the oven. These surfaces may be hot enough to burn even though they are dark in color. During and after use, do not touch, or let clothing or other flammable materials contact any interior area of the oven; allow sufficient time for cooling first. Other surfaces of the appliance may become hot enough to cause burns. Potentially hot surfaces include the burners, grates, oven vent opening, surfaces near the opening and crevices around the oven door.

## READ AND SAVE THESE INSTRUCTIONS

# IMPORTANT SAFETY INFORMATION

## **⚠ WARNING** GENERAL SAFETY INSTRUCTIONS (Cont.)

- Do not heat unopened food containers. Pressure could build up and the container could burst, causing an injury.
- Cook food thoroughly to help protect against foodborne illness. Minimum safe food temperature recommendations can be found at [www.IsItDoneYet.gov](http://www.IsItDoneYet.gov) and [www.fsis.usda.gov](http://www.fsis.usda.gov). Use a food thermometer to take food temperatures and check several locations.
- Do not allow anyone to climb, stand or hang on the oven door, drawer or cooktop. They could damage the range or tip it over causing severe injury or death.

## **⚠ WARNING** KEEP FLAMMABLE MATERIALS AWAY FROM THE RANGE

Failure to do so may result in fire or personal injury.

- Do not store or use flammable materials in an oven or near the cooktop, including paper, plastic, pot holders, linens, wall coverings, curtains, drapes and gasoline or other flammable vapors and liquids.
- Never wear loose-fitting or hanging garments while using the appliance. These garments may ignite if they contact hot surfaces causing severe burns.
- Do not let cooking grease or other flammable materials accumulate in or near the range. Grease in the oven or on the cooktop may ignite.

## **⚠ WARNING** IN THE EVENT OF A FIRE, TAKE THE FOLLOWING STEPS TO PREVENT INJURY AND FIRE SPREADING

- Do not use water on grease fires. Never pick up a flaming pan. Turn the controls off. Smother a flaming pan on a surface burner by covering the pan completely with a well-fitting lid, cookie sheet or flat tray. If necessary, use a multi-purpose dry chemical or foam-type fire extinguisher.
- If there is a fire in the oven during baking, smother the fire by closing the oven door and turning the oven off or by using a multi-purpose dry chemical or foam type fire extinguisher.
- If there is a fire in the oven during self-clean, turn the oven off and wait for the fire to go out. Do not force the door open. Introduction of fresh air at self-clean temperatures may lead to a burst of flame from the oven.

## **⚠ WARNING** SELF-CLEANING OVEN SAFETY INSTRUCTIONS (on some models)

The self-cleaning feature operates the oven at temperatures high enough to burn away food soils in the oven. Follow these instructions for safe operation.

- Do not touch oven surfaces during self-clean operation. Keep children away from the oven during self-cleaning. Failure to follow these instructions may cause burns.
- Before operating the self-clean cycle, remove pans, shiny metal oven racks and other utensils from the oven. Only porcelain-coated oven racks may be left in the oven.
- Before operating the self-clean cycle, wipe grease and food soils from the oven. Excessive amount of grease may ignite leading to smoke damage to your home.
- If the self-cleaning mode malfunctions, turn the oven off and disconnect the power supply. Have it serviced by a qualified technician.
- Do not use oven cleaners. No commercial oven cleaner or oven liner protective coating of any kind should be used in or around any part of the oven.
- Do not clean the door gasket. The door gasket is essential for a good seal. Care should be taken not to rub, damage or move the gasket.
- **IMPORTANT:** The health of some birds is extremely sensitive to the fumes given off during the self-cleaning cycle of any range. Move birds to another well-ventilated room.

## **⚠ WARNING** COOKTOP SAFETY INSTRUCTIONS

- Never leave the surface burners unattended at medium or high heat settings. Foods, especially oily foods, may ignite resulting in fire that could spread to surrounding cabinets.
- Never leave oil unattended while frying. If allowed to heat beyond its smoking point, oil may ignite resulting in fire that may spread to surrounding cabinets. Use a deep fat thermometer whenever possible to monitor oil temperature.
- To avoid oil spillover and fire, use a minimum amount of oil when shallow pan-frying and avoid cooking frozen foods with excessive amounts of ice.
- Use proper pan size and avoid pans that are unstable or easily tipped. Select cookware that is matched to the size of the burner. Burner flames should be adjusted so that they do not extend beyond the bottom of the pan. Excessive flame may be hazardous.

# READ AND SAVE THESE INSTRUCTIONS

# IMPORTANT SAFETY INFORMATION

## **⚠ WARNING** COOKTOP SAFETY INSTRUCTIONS (Cont.)

- Always use the LITE position when igniting the top burners and make sure the burners have ignited.
- When using glass/ceramic cookware, make sure it is suitable for cooktop service; others may break because of sudden change in temperature.
- To minimize the possibility of burns, ignition of flammable materials and spillage, the handle of a container should be turned toward the center of the range without extending over nearby burners.
- Do not use a wok with a round metal support ring. The ring may trap heat and block air to the burner resulting in a carbon monoxide hazard.
- Do not attempt to lift the cooktop. Doing so may damage the gas tubing to the surface burners resulting in a gas leak and risk of fire.
- When disabling Lock Control (on some models), make sure the surface controls are set to the OFF position. This will prevent unintended gas flow from the burners.
- Do not use aluminum foil to cover the grates or line any part of the cooktop. Doing so may result in carbon monoxide poisoning, overheating of the cooktop surfaces, or a potential fire hazard.

## **⚠ WARNING** OVEN SAFETY INSTRUCTIONS

**⚠ WARNING** NEVER cover any slots, holes, or passages in the oven bottom or cover an entire rack with materials such as aluminum foil or oven liners. Doing so blocks air flow through the oven and may cause carbon monoxide poisoning. Never place foil or oven liners on the oven bottom. They can trap heat causing risk of smoke or fire.

- Stand away from the range when opening the oven door. Hot air or steam which escapes can cause burns to hands, face and/or eyes.
- Never place cooking utensils, pizza or baking stones, or any type of foil or liner on the oven floor. These items can trap heat or melt, resulting in damage to the product and risk of shock, smoke or fire.
- Place oven racks in desired location while oven is cool. If rack must be moved while oven is hot, be careful to avoid touching hot surfaces.
- Do not leave items such as paper, cooking utensils or food in the oven when not in use. Items stored in an oven can ignite.
- Do not leave items on the cooktop near the oven vent. Items may overheat resulting in a risk of fire or burns.
- Never broil with door open. Open-door broiling is not permitted due to overheating of control knobs.

## READ AND SAVE THESE INSTRUCTIONS

### Using Your New Appliance

**NOTE:** Remove all protective packing before operating the oven.

The full owner's manual for your product includes additional information and cooking guides. Access the manual by searching for your appliance model number at [www.GEAppliances.com](http://www.GEAppliances.com).

### Using The Cooktop

#### How to Light a Surface Burner

**⚠ WARNING** Burners should be operated only when covered by cookware. Burner flames not covered by cookware present a risk of fire or clothing ignition. Never let flames extend beyond the sides of the cookware. Failure to comply may result in serious injury.

Make sure all burners are in their correct locations and fully assembled before attempting to operate any burner. Select a burner and find its control knob. Push the knob in and turn it to the LITE position.

#### In Case of a Power Failure

In the event of a power failure, the oven is inoperable and no attempt should be made to operate it. However, the surface burners may be lit with a match. Using extreme caution, hold a lit match near the ports beneath the surface burner cap, then slowly turn the knob to the LITE position. Once lit, surface burners will continue to operate normally.

You will hear a clicking noise—the sound of the electric spark igniting the burner. When one burner is turned to LITE, all burners will spark. Sparking will continue as long as the knob remains at LITE. Once gas is ignited, turn the knob to adjust the flame size.

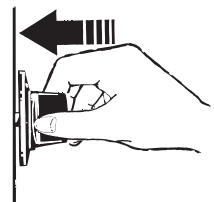

Push the control knob in and turn it to the LITE position.



# Using The Cooktop (Cont.)

## How to Select Flame Size

Watch the flame, not the knob, as you adjust heat. When rapid heating is desired, the flame size on a burner should match the size of the cookware you are using. Flames

larger than the bottom of the cookware will not heat faster and may be hazardous.



## How to Use Your Griddle (on some models)

For complete griddle information, see the full owner's manual at [www.GEAppliances.com](http://www.GEAppliances.com).

### **WARNING** Fire Hazard

- Use care when cooking greasy foods. Spilled grease can result in fire.
- Never place any items on the griddle when it is not in use. Heat from surrounding burners can heat the griddle and can result in fire.
- Place and remove the griddle only when all grates and griddle are cool and all surface burners are turned OFF.

Before first use, rinse with hot water and dry thoroughly. Prepare surface with vegetable oil or cooking spray. The griddle can only be used over the center oval burner. Remove the center grate (if present) and replace with griddle.

**Do not overheat the griddle.** Leaving the griddle burner on at HI for an extended amount of time without food can damage the nonstick coating.

Avoid using metal utensils with sharp points or rough sharp edges which might damage the griddle surface.

## Cleaning The Cooktop

For complete information about cleaning the cooktop, see the full owner's manual at [www.GEAppliances.com](http://www.GEAppliances.com).

Remove surface burners for cleaning as shown below. Wash burner caps and burner heads in hot soapy water and rinse with clean water. The ports in the burner heads must be kept clean at all times for an even, unhampered flame. Clogged or dirty burner ports will not allow burner to operate properly. Before putting burners back on the range, shake out any excess water and allow them to dry thoroughly.

### **CAUTION** Do not operate the cooktop without all burner parts and grates in place.

## Removal of Surface Burners for Cleaning

Turn all controls OFF. Allow cooktop to cool before removing grates and burner parts. When removing the burner caps and heads, remember their size and location. Replace them in the same location after cleaning.

Any spill on or around an electrode must be carefully cleaned. Take care to not hit an electrode with anything hard or it could be damaged.

The electrode of the spark igniter is exposed when the burner head is removed. When one burner is turned to LITE, all the burners spark. Do not attempt to disassemble or clean around any burner while another burner is on. Damage to the product may occur.

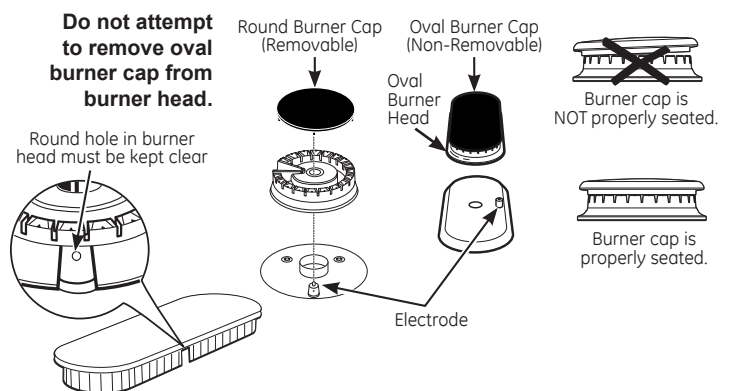

## Oven Controls

For complete information about the oven controls, see the full owner's manual at [www.GEAppliances.com](http://www.GEAppliances.com).

**Start:** Must be pressed to start any cooking, cleaning, or timed function.

**Clock:** Sets the oven clock time. Press both the + and - pads and hold for 3 seconds or press the **Set Clock** pad (on some models). Use the + and - pads to program the clock. Press **Start** to save the time.

**Cook Time:** Counts down cooking time and turns off the oven when the cooking time is complete. Press the **Cook Time** pad, use the number pads to program a cooking time in hours and minutes, then press **Start**. This can only be used with Traditional Bake and Convection Bake.

**Timer:** Works as a countdown timer. Press the **Timer** pad and the + and - pads to program the time in hours and minutes. Press the **Start** pad. The oven will continue to operate when the timer countdown is complete. To turn the timer off, press the **Timer** pad.

**Delay Time:** Delays when the oven will turn on. Use this to set a time when you want the oven to start. Press the **Delay Time** pad, and use the + and - pads to program the time of day for the oven to turn on. Press the desired cooking mode and temperature, then press **Start**. A cook time may also be programmed if desired. This can only be used with Traditional Bake, Convection Bake, and Self-Clean (on some models).

# Cooking Modes and Recommendations

Follow these general recommendations for better results. For a complete cooking guide with recommended cooking modes and food positions, see the full owner's manual at [www.GEAppliances.com](http://www.GEAppliances.com).

**Bake:** Place food in approximately the center of the oven. When baking on a single rack use position 3 or 4. When baking on multiple racks use positions 3 and 5. If baking on multiple racks in traditional bake mode, switch food location partially through cooking for more even results. When baking multiple items, ensure there is space between items.

**Convection Bake (some models):** Use this mode for baking on multiple racks. Use positions 3 and 5. Your oven is equipped with Auto Recipe Conversion, so it is not necessary to adjust the temperature when using convection bake.

**Broil:** Always broil with the door closed. For better searing use the rack position that places food closest to the broil heater. Move food down or use Broil Lo mode for more doneness/less searing. Some models have a broil drawer with three broiling positions. In positions B and C, the broil pan (some models) or rack (some models) rests on the supports. In the bottom position (A), cookware sits directly on the drawer bottom. Take care not to touch the inner door when placing and removing food on the drawer bottom.

**NOTE:** Remove unused racks from oven and/or drawer for faster preheat, improved efficiency, and optimal performance.

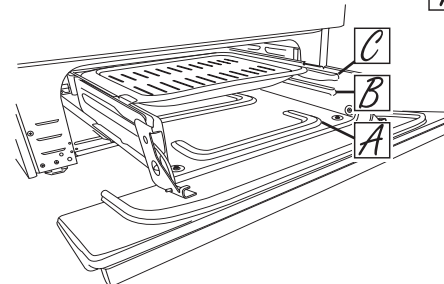
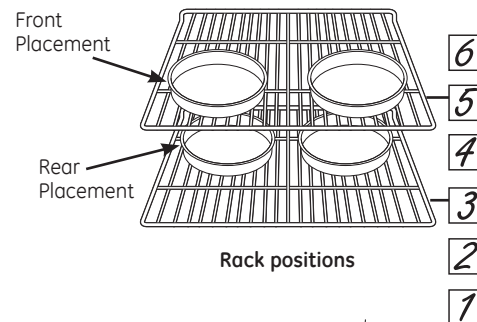
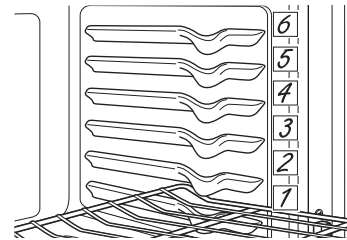

Drop-down Slide-out Broil Drawer (some models)

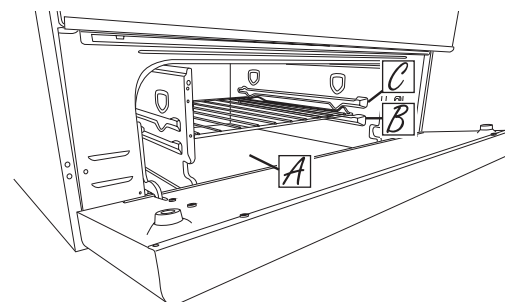

Drop-down Broil Drawer (some models)

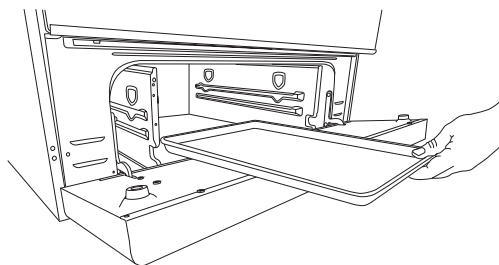

When placing cookware on the rack or drawer bottom, use front-to-back orientation for easier placement and better coverage.

## Special Features

For other special features such as Sabbath mode, see the full owner's manual at [www.GEAppliances.com](http://www.GEAppliances.com).

There are several different special features on your range. To change the settings of these special features:

- Press the **Bake** and **Broil** pads at the same time and hold for three seconds.
- "SF" will appear in the display.
- Select the feature you want to change. See full owner's manual for details on how to select different features.
- When the change has been made, press the **Start** key to save the change and return to the time of day.

### Adjust the Oven Temperature

This feature allows the oven baking temperature to be adjusted up to 35°F hotter or down to 35°F cooler. Use this feature if you believe your oven temperature is too hot or too cold and wish to change it. This adjustment affects every cooking mode except broil.

After entering the special features menu, press the **Bake** pad to enter the temperature adjustment mode. A number between 35 and - 35 will display. Use the +/- pads to set the desired temperature adjustment. Press the **Start** pad to save the temperature adjustment.

# Aluminum Foil and Oven Liners



**Do not use any type of foil or oven liner to cover the oven bottom. These items can block airflow or melt, resulting in damage to the product and risk of carbon monoxide poisoning, smoke or fire. Damage from improper use of these items is not covered by the product warranty.**

Foil may be used to catch spills by placing a sheet on a lower rack, several inches below the food. Do not use more foil than necessary, and never entirely cover an oven rack with aluminum foil. Keep foil at least 1-1/2" from oven walls to allow proper heat circulation.

## Cleaning the Oven

**For complete information about cleaning the oven, see the full owner's manual at [www.GEAppliances.com](http://www.GEAppliances.com).**

Be sure all controls are off and all surfaces are cool before cleaning any part of the range.

### Manual Cleaning

Do not use oven cleaners, strong liquid cleansers, steel wool, or scouring pads on the interior of the oven. For soils on the oven bottom and other enameled surfaces, use a gentle abrasive containing oxalic acid, such as Bar Keepers Friend®, with a non-scratch sponge. Take care not to apply any abrasive cleaners or sponges to the

door glass, as it will scratch the reflective coating. The oven interior and door glass may be cleaned using a soft cloth with a mild soap and water, or vinegar and water solution. After cleaning, rinse with clean water and dry with a soft cloth.

### Self Clean Mode (on some models)

Read the Self-Cleaning Oven Safety Instructions at the beginning of this manual before using Self Clean Mode. Remove all items from the oven. Close and latch the door. If the oven is too hot, you will not be able to slide the latch. Press the **Self Clean** pad. Use the **+** and **-** pads to enter any time between 3 and 5 hours and press **Start**. For a

moderately soiled oven, run a 3 hour self-clean cycle. For a heavily soiled oven, run a 5 hour self-clean cycle. The oven will turn off when the self-clean cycle is complete. The door cannot be unlatched until the oven has cooled below the unlocking temperature. After the oven has cooled down, wipe ash out of the oven.

### Steam Clean Mode (on some models)

The Steam Clean feature is for cleaning light soils. To use the Steam Clean feature wipe grease and soils from the oven. Pour one cup of water into the bottom of the oven. Close and latch the door (some models). Press the **Steam Clean** pad then press **Start**. You cannot open

the door during the 30 minute steam clean. When the cycle completes, unlatch and/or open the door, soak up remaining water, and wipe away moisture-softened soils from the oven walls and door. See instructions in Manual Cleaning for any remaining soils.

## Troubleshooting

**For additional troubleshooting tips, see the full owner's manual at [www.GEAppliances.com](http://www.GEAppliances.com).**

Problem	Possible Cause	What To Do
My new oven doesn't cook like my old one. Is something wrong with the temperature settings?	Your new oven has a different cooking system from your old oven and therefore may cook differently than your old oven.	Refer to the Cooking Guide in the full owner's manual for recommendations. If you think your new oven is too hot or too cold, you can adjust the temperature to meet your preferences. See the Special Features section.
Oven light does not work	Light bulb is loose or defective.	Tighten or replace bulb. See full owner's manual.
Oven will not self-clean	The temperature is too high to set a self-clean operation.	Allow oven to cool.
	Oven controls improperly set.	See the Cleaning the Oven section.
Excessive smoking during clean cycle	Excessive soil or grease.	Press the <b>Cancel/Off</b> pad. Wipe up the excess soil and reset the clean cycle.
Oven door will not open	Temperature inside the oven has not dropped below the unlocking temperature.	Press the <b>Cancel/Off</b> pad. Allow the oven to cool below the unlocking temperature.
Top burners do not burn evenly	Improper burner assembly.	Make sure the burner caps are seated correctly. See the Cleaning the Cooktop section.
	Burner slots on the side of the burner may be clogged.	Remove the burners for cleaning. See the Cleaning the Cooktop section.
Oven temperature too hot or too cold	Oven temperature needs adjustment.	See the Special Features section.

# Thank You! ... for your purchase of a GE Brand appliance.

**Register Your Appliance:** Register your new appliance online at your convenience!

[www.geappliances.com/service\\_and\\_support/register/](http://www.geappliances.com/service_and_support/register/)

Timely product registration will allow for enhanced communication and prompt service under the terms of your warranty, should the need arise. You may also mail in the pre-printed registration card included in the packing material.

## GE Gas Range Warranty

### GEAppliances.com

All warranty service is provided by our Factory Service Centers, or an authorized Customer Care® technician. To schedule service online, visit us at [www.geappliances.com/service\\_and\\_support/](http://www.geappliances.com/service_and_support/), or call 800.GE.CARES (800.432.2737). Please have serial number and model number available when calling for service.

Servicing your appliance may require the use of the onboard data port for diagnostics. This gives a GE factory service technician the ability to quickly diagnose any issues with your appliance and helps GE improve its products by providing GE with information on your appliance. If you do not want your appliance data to be sent to GE, please advise your technician not to submit the data to GE at the time of service.

For the period of one year from the date of the original purchase, GE will provide any part of the range which fails due to a defect in materials or workmanship. During this limited one-year warranty, GE will also provide, free of charge, all labor and in-home service to replace the defective part.

### What GE will not cover:

- Service trips to your home to teach you how to use the product.
- Improper installation, delivery or maintenance.
- Failure of the product if it is abused, misused, modified or used for other than the intended purpose or used commercially.
- Replacement of house fuses or resetting of circuit breakers.
- Damage to the product caused by accident, fire, floods or acts of God.
- Damage to finish, such as surface rust, tarnish, or small blemishes not reported within 48 hours of delivery.
- Incidental or consequential damage caused by possible defects with this appliance.
- Damage caused after delivery.
- Product not accessible to provide required service.
- Service to repair or replace light bulbs, except for LED lamps.

### EXCLUSION OF IMPLIED WARRANTIES

Your sole and exclusive remedy is product repair as provided in this Limited Warranty. Any implied warranties, including the implied warranties of merchantability or fitness for a particular purpose, are limited to one year or the shortest period allowed by law.

This warranty is extended to the original purchaser and any succeeding owner for products purchased for home use within the USA. If the product is located in an area where service by a GE Authorized Servicer is not available, you may be responsible for a trip charge or you may be required to bring the product to an Authorized GE Service location for service. In Alaska, the warranty excludes the cost of shipping or service calls to your home.

Some states do not allow the exclusion or limitation of incidental or consequential damages. This warranty gives you specific legal rights, and you may also have other rights which vary from state to state. To know what your legal rights are, consult your local or state consumer affairs office or your state's Attorney General.

**Warrantor: General Electric Company. Louisville, KY 40225**

**Extended Warranties:** Purchase a GE extended warranty and learn about special discounts that are available while your warranty is still in effect. You can purchase it online anytime

[www.geappliances.com/service\\_and\\_support/shop-for-extended-service-plans.htm](http://www.geappliances.com/service_and_support/shop-for-extended-service-plans.htm)

or call 800.626.2224 during normal business hours. GE Consumer Home Services will still be there after your warranty expires.

Staple your receipt here. Proof of the original purchase date is needed to obtain service under the warranty.